

TABLE OF CONTENTS



The LIGHTWALL 3440 at the Pathways Innovation Center in Casper, WY. Designed by the Cunningham Group

LIGHTWALL 3440®	1
LIGHTWALL 3100LS®	5
LIGHTWALL 3000®	9
SKYSHADE 3100®	13
SKYSHADE 3300®	17
TECHVENT 5300®	21
SKYGARD 3300®	25
SKYGARD 3700®	29
KINETICWALL™	31

ABOUT EXTECH

Since our inception in 1975, EXTECH/Exterior Technologies, Inc. has developed more than 20 unique systems and worked on thousands of projects across North America. Our daylighting systems and custom façades have delivered solutions for a wide variety of industries and applications, and EXTECH’s commitment to collaboration and innovation has won numerous awards and garnered national attention.

We are committed to delivering our best work through in-house fabrication, research and development, and close client partnership. On every project, EXTECH’s project managers, architects, and engineers strive to provide the technical expertise, imaginative ingenuity, and dedicated teamwork that builds lifetime relationships.



A custom designed Prodema panel facade for the Harry Parker Boathouse in Brighton, MA. Designed by Anmahian Winton Architects, and winner of the 2014 AIA Honor Award for Architecture

Our Mission: Deliver solutions that elegantly meet the demands of the project through collaboration, innovation, and exceptional engineering.

LIGHTWALL 3440[®]

INTERLOCKING WALL SYSTEM

LOGAN AIRPORT HANGARS | BOSTON, MA

DESIGNED BY FENNICK MCCREDIE ARCHITECTURE

This project included a series of sloped doors glazed with 3-story tall polycarbonate panels, alternating between opal and clear. Many daylighting façades were considered but were passed over in favor of EXTECH's LIGHTWALL 3440 system.

This system was selected because its translucent panels provide optimal light transmission, and the lightweight material provides efficient operation of the sliding doors. EXTECH developed a custom sloping panel detail to accommodate the angled hangar doors, while still meeting the challenge of a compressed project timeline.

*BIM, CAD, and Specification documentation available on our website.
System sample available upon request.*

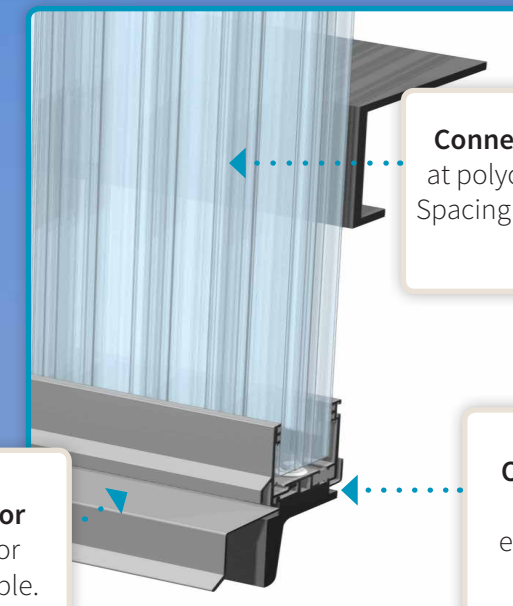

Connection clips are placed at polycarbonate panel joints. Spacing of clips varies based on application.

Sill flashing sloped for weepage. Anodized or painted finishes available.

Optional thermal break provides better energy-efficiency for conditioned spaces.



LIGHTWALL 3440[®] INTERLOCKING WALL SYSTEM

The LIGHTWALL 3440 translucent wall panel system offers energy savings, high-impact resistance, and outstanding insulation value. The LIGHTWALL 3440 has provided solutions for a wide range of structures in a wide range of industries, and has been subjected to ASTM air, water, structural, and flammability testing.

FURTHER BENEFITS AND DETAILS

- ▶ Tongue & Groove joinery provides clean, modern appearance without the need for framing between individual panels
- ▶ Structural cellular polycarbonate panels are 500mm (19-11/16") wide
- ▶ Vertical panels up to 54 feet long eliminate leak-prone horizontal joints
- ▶ Provides comfortable, diffused daylighting
- ▶ Highly insulating, up to R-4 for 40mm thick panels and R-5 for 50mm thick panels
- ▶ Polycarbonate cannot "fiber-bloom" or delaminate like Fiberglass Reinforced Panels (FRP)
- ▶ Lightweight panels install quickly for reduced installation cost
- ▶ Perimeter framing systems for new construction and retrofit work
- ▶ Low-friction gaskets for long life
- ▶ Available in various colors and translucencies
- ▶ LEED credits available for 100% recyclable polycarbonate & aluminum framing
- ▶ Available in ASTM E-84 Class A, CC-1 fire rated material



FLAMMABILITY TESTING

- ▶ Self-ignition: ASTMD-1929
- ▶ Smoke Density: ASTM D-2843
- ▶ Burn Extent: ASTM D-635
- ▶ Interior Flame Spread: ASTM E-84

WEATHERING

- ▶ Color Change: ASTM D-2244
- ▶ Yellowing Index: ASTM D-1925
- ▶ Light Transmission: ASTM D-1003

MISCELLANEOUS

- ▶ Air Infiltration: ASTM E-283
- ▶ Water Infiltration: ASTM E-331
- ▶ Load Bearing Capability: E-330
- ▶ U-Value: NFRC C-518



LIGHTWALL 3100LS[®]

LONG-SPANNING WALL SYSTEM

THYSSENKRUPP STEEL | CALVERT, AL

German steel giant ThyssenKrupp approached EXTECH during the value engineering phase for their new U.S. based mill. The original building design specified channel glass - an expensive high-end glass material - and it far exceeded their exterior glazing budget.

Our LIGHTWALL 3100LS delivered the sleek style and daylighting capabilities of the original design, for less cost. The LIGHTWALL 3100LS is a long spanning structural standing seam wall system that requires minimal structural support, and mimics the look of channel glass.

ThyssenKrupp saved 66% on their exterior glazing budget by using the LIGHTWALL 3100LS. The completed project represents one of the largest cellular polycarbonate glazing installations in North America, utilizing over 310,000 square feet of glazing and nearly 40 linear miles of the aluminum mullion extrusions.

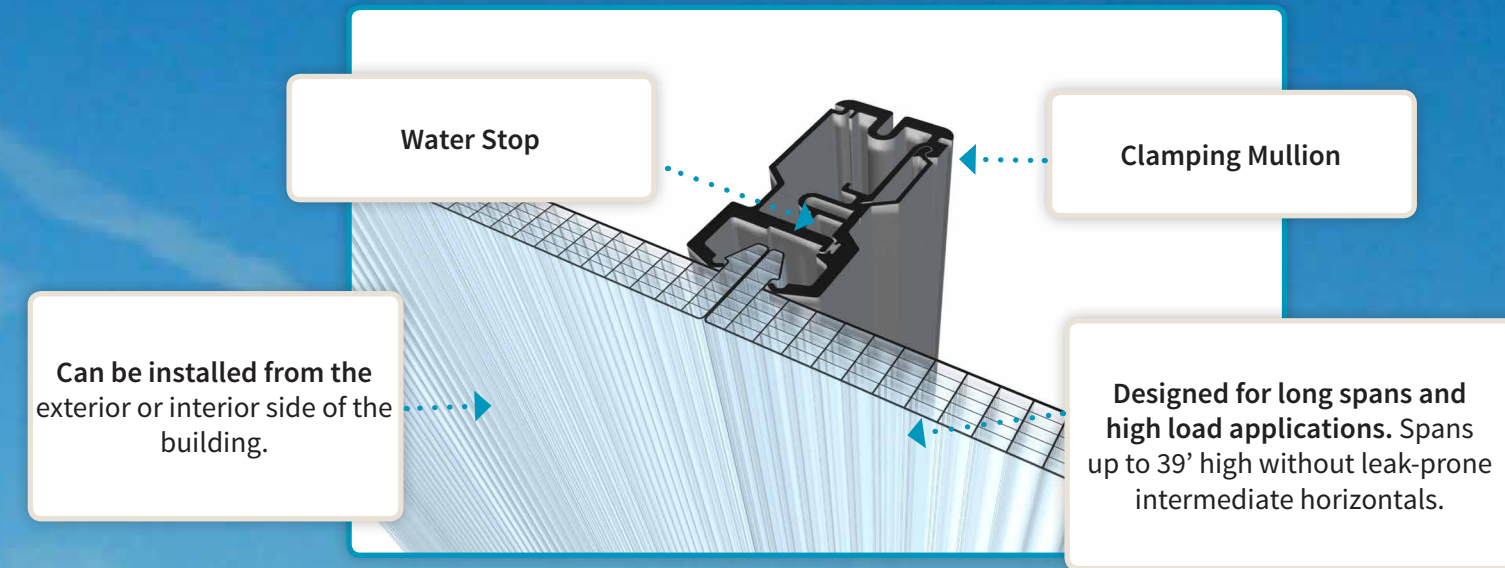

*CAD and Specification documentation available on our website.
System sample available upon request.*

LIGHTWALL 3100LS[®]

LONG-SPANNING WALL SYSTEM

EXTECH's LIGHTWALL 3100LS translucent wall system delivers all the benefits of daylighting façades while being capable of long spans with minimal structural support. Comprised of a patented interlocking clamping structural mullion designed for high wind load and long span conditions, the 3100LS provides a continuous wall of daylight that replicates the external appearance of a channel glass system at a fragment of the cost.

FURTHER BENEFITS AND DETAILS

- ▶ Fully fabricated
- ▶ Spans up to 12 meters (39') high, without leak prone intermediate horizontals
- ▶ Internal gaskets stop water for long-term performance
- ▶ Easy connection to a variety of horizontal building girt configurations
- ▶ Can be installed from either the exterior or interior side of the building
- ▶ Replaceable lightweight glazing panels are only 0.655 lbs/sf
- ▶ Large missile impact tested to 8' spans
- ▶ Meets ASTM E-84 test for Class A material
- ▶ Meets ASTM E-1886 and E-1996 test for hurricane impact / windborne debris at clear spans of 8 feet
- ▶ Thermally efficient glazing R-3.79 (U=0.264)
- ▶ Glazing available in a variety of colors and translucencies
- ▶ Fully recyclable system with available LEED credits

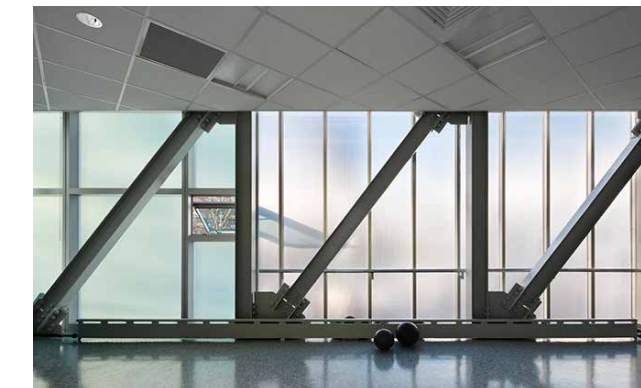

LIGHTWALL 3000[®]

CURTAIN WALL SYSTEM

OTTERBEIN UNIVERSITY | WESTERVILLE, OH

DESIGNED BY MOODY NOLAN

Otterbein University's STEAM Innovation Center is a renovation of an older campus building. The architect had a unique design in mind – a multi-paneled, geometric façade that would deliver daylighting with minimized solar heat gain and glare. The plan was to use a curtain wall that incorporated metal, polycarbonate, and glass and delivered diffused daylight with visual clarity in key locations.

EXTECH's LIGHTWALL 3000 curtain wall system was selected because it is one of the few that properly accommodates both polycarbonate and glass glazing within the same system. This is accomplished by using deep glazing pockets and low-friction gaskets that allow thermal movement of the polycarbonate, while still providing superior water and air performance.

Properly accepts both insulated glass, metal, and cellular polycarbonate panels. This can be done within the same framing system.

Excellent internal water control. Dams at ends of each horizontal mullion to direct water to weep holes.

Optional aluminum caps snap onto the pressure caps to provide a finished architectural appearance.

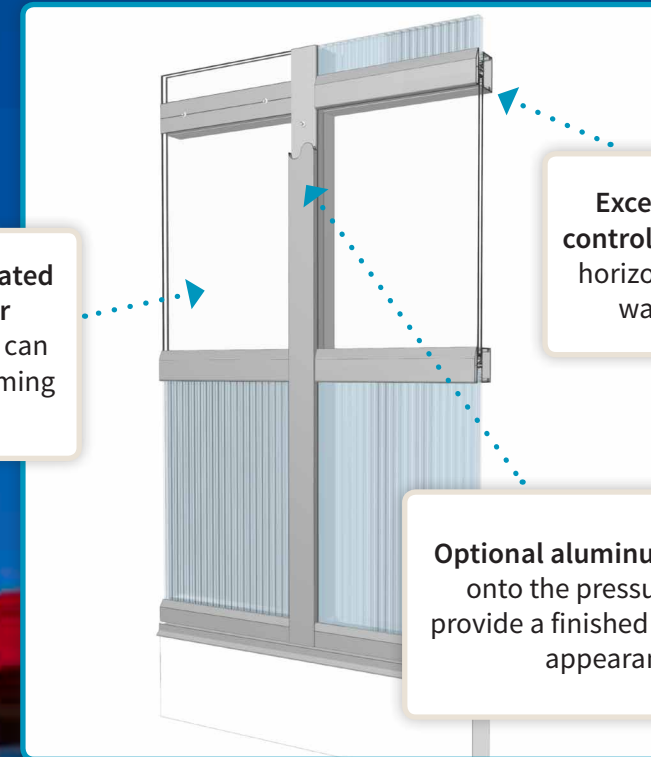

CAD and Specification documentation available on our website.
System sample available upon request.

LIGHTWALL 3000® CURTAIN WALL SYSTEM

The LIGHTWALL 3000 is one of the few curtain wall systems that can properly accept both glass and polycarbonate panels. It creates a brighter environment, helps save on energy costs, and can earn credits toward LEED certification. The LIGHTWALL 3000 delivers benefits for a wide variety of applications, from structures focused on aesthetic presentation to those concerned with robust durability.

FURTHER BENEFITS AND DETAILS

- ▶ Fully fabricated
- ▶ Deep glazing channels
- ▶ Low-friction gasketing
- ▶ Controlled gasket pressure
- ▶ Has been tested to the AAMA standards for air infiltration, water infiltration, and structural strength
- ▶ Shallow vertical mullion option allows for placement of the system on existing structure
- ▶ Deep vertical mullion option allows for large vertical span
- ▶ Excellent internal water control. End dams at ends of each horizontal mullion to direct water to weep holes
- ▶ Components are completely fabricated at the factory, including the insertion of gasketing, allowing for rapid field erection
- ▶ Optional aluminum caps snap onto the pressure caps to provide a finished architectural appearance
- ▶ Chosen as one of Architectural Record's "Product Reports" winners
- ▶ 100% recyclable system with available LEED points



SKYSHADE 3100®

STANDING SEAM CANOPY

COPPER CANYON SCHOOL | TOOELE, UT

EXTECH's SKYSHADE 3100 standing seam canopy system was chosen for this project because its ability to be field cold-formed provided substantial savings over a curved glass canopy. Unlike other systems on the market, SKYSHADE's superior perimeter framing reduces noise from thermal expansion, and its co-extruded UV protection layer offers longevity and durability. Because of its 100% recyclability, it aligned with the Copper Canyon School's sustainability practices.

CAD and Specification documentation available on our website.
System sample available upon request.

Patented two-piece stainless steel clip slides to accommodate the expansion and contraction of the polycarbonate panels.

Translucent polycarbonate battens with Snap Fit joinery provide clean appearance without the need for intermediate framing.

Only EXTECH offers an aluminum cap over the ends of battens.

Continuous hinged framing allows for easy installation in various sloping conditions.

Holes are drilled into the base of the female extrusion to weep any water that may enter the system.

SKYSHADE 3100® STANDING SEAM CANOPY

EXTECH's SKYSHADE 3100 is a standing seam canopy system that offers continuous glazing panels with standing legs on both sides. Snap-on battens secure these legs. It is built with the most advanced aluminum perimeter framing system in the industry and delivers outstanding long-term performance. Low-friction gaskets accommodate thermal movement of longer polycarbonate panels. This eliminates noise from thermal movement and provides for a longer system lifespan.

FURTHER BENEFITS AND DETAILS

- ▶ Fully fabricated
- ▶ Polycarbonate panels up to 54 feet long eliminate the need for leak-prone horizontal joints
- ▶ Curves easily without added costs, unlike glass or FRP
- ▶ Snap-Fit joinery provides clean appearance without intermediate framing
- ▶ Translucent polycarbonate battens are spaced 23 3/4" on center
- ▶ Highly impact resistant
- ▶ Lightweight panels install easily and reduce installation costs
- ▶ Provides comfortable, diffused daylight and protection from the elements
- ▶ Works well for new construction and retrofit where purlins are spaced 2' to 4' on center
- ▶ LEED credits available for 100% recyclable polycarbonate and aluminum framing
- ▶ Available in ASTM E-84 Class A, CC-1 fire rated material



SKYSHADE 3300®

SURFACE MOUNTED CANOPY

DELAWARE TECHNICAL COMMUNITY COLLEGE | NEWARK, DE

DESIGNED BY TEVEBAUGH ASSOCIATES

The Delaware Technical Community College canopy project presented more challenges than one would think. The project architect wanted a sleek, free-standing marquee-shaped canopy with integrated up-lighting. Because of its size (80 feet long, 32 feet wide), a free-standing canopy with a consistent look would be difficult to achieve.

To create the elegant look desired by the architect and the college, EXTECH engineered the use of full-length, monolithic glazing to eliminate the cross mullions, hide a majority of the framing, and create a sleek, long-spanning look. To our knowledge, monolithic polycarbonate had never been installed in such long sheets; this was a notable achievement in polycarbonate canopy design.

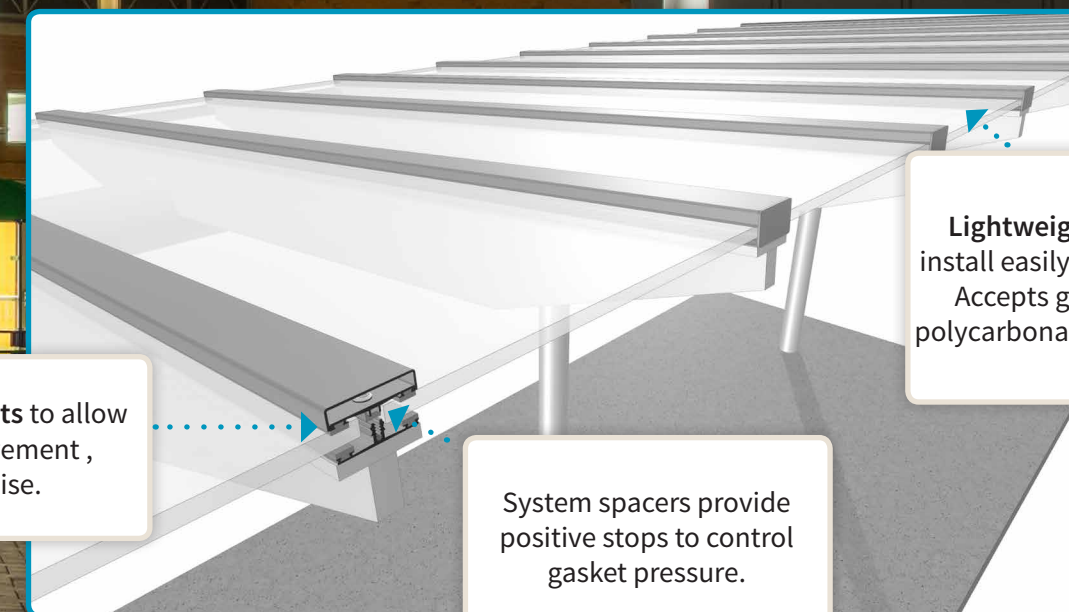

Low-friction gaskets to allow for thermal movement, reducing noise.

System spacers provide positive stops to control gasket pressure.

Lightweight panels and components install easily and reduce installation costs. Accepts glass, monolithic, or cellular polycarbonate sheets from 1/4" to 1" thick.

SKYSHADE 3300® SURFACE MOUNTED CANOPY

EXTECH's SKYSHADE 3300 is a surface mounted, single-glazed translucent polycarbonate canopy for applications over an existing structure. It is a simple system with aluminum pressure caps and shallow rafter extrusions that are designed to be placed on continuous structural rafters. It provides daylighting, high-insulation value, UV protection, and impact resistance.

FURTHER BENEFITS AND DETAILS

- ▶ Fully fabricated
- ▶ Highly impact resistant
- ▶ Lightweight panels and components install easily and reduce installation costs
- ▶ Possesses plastic spacers for positive stops to control gasket pressure
- ▶ Glazing gaskets have a low coefficient of friction surface to allow for thermal movement
- ▶ LEED credits available for 100% recyclable polycarbonate and aluminum framing
- ▶ Panels are available in a variety of colors and translucencies
- ▶ Framing is available in a variety of finishes



TECHVENT 5300®

TOP-HINGED INDUSTRIAL WINDOW

GLOBAL TECHNOLOGY PROVIDER | NORTH CAROLINA

DESIGNED BY O'BRIEN/ATKINS ASSOCIATES

A leading global technology provider specializing in cloud storage and data co-location was rapidly expanding. They were outgrowing their research and development facility and needed to build a new one to accommodate their increasing workforce and mounting client demands. While the need was immediate, the expansion couldn't be hasty – it had to meet the client's rigorous sustainability and energy-conserving standards.

The architect's original concept utilized pneumatically controlled louvers. EXTECH proposed an alternate arrangement utilizing our TECHVENT 5300 system. The continuous TECHVENT louvers were motorized and integrated with the building's HVAC control system. This integration allowed the HVAC system to utilize natural ventilation while still admitting daylight into the structure. The TECHVENT 5300 was used for approximately 22,000 square feet of operating and fixed windows, complete with bird screens. When all was said and done, the expansion exceeded its energy-efficiency goals.

Continuous units — factory assembled sections feature interlocking vertical mullions. Can be installed as smaller units. Can be incorporated into other EXTECH wall systems.

Vents available in individual units or in “runs” up to 150'0” wide. Typical height of top-hinged windows is 3' to 5' tall.



Provides natural light and massive natural ventilation. Patented top-hinged design allows operating windows to be left open during normal rainfall.

*CAD and Specification documentation available on our website.
System sample available upon request.*

TECHVENT 5300®

TOP-HINGED INDUSTRIAL WINDOW

EXTECH's TECHVENT 5300 is a top-hinged window/louver system which can be left open during normal rainfall. It provides natural lighting and massive ventilation and is great for new construction or retrofit work. It can be operated either manually or electrically and is available with thermally broken framing. The TECHVENT 5300 can be installed in individual openings or in long continuous runs.

FURTHER BENEFITS AND DETAILS

- ▶ Reduces the need for multiple building penetrations
- ▶ Accepts glass or polycarbonate up to 1" thick
- ▶ Finish on aluminum framing can be your choice of anodized or high-performance factory baked paints
- ▶ Vents available in individual units or in runs up to 150' wide
- ▶ Continuous runs — factory assembled sections feature interlocking vertical mullions. Can be installed as smaller units
- ▶ Deep glazing pockets (rabbet depth) accommodate thermal movement of polycarbonate glazing
- ▶ "Dry glazed" - low friction gasketing to maintain good air and water infiltration seals, while allowing for thermal movement of the polycarbonate glazing
- ▶ Can be installed on a slope to form operating skylights
- ▶ Continuous hinge provides uncompromised strength. Tested to hurricane-force winds
- ▶ Units available up to 8' tall
- ▶ Available with Class A polycarbonate glazing attaining up to an R-3.8 insulating factor



SKYGARD 3300[®]

SURFACE MOUNTED SKYLIGHT

GENERAL ELECTRIC/SABIC HEADQUARTERS | PITTSFIELD, MA

General Electric had a big problem with their U.S. Headquarters: built in the 1970s, the facility's skylights and metal roofing were leaking badly. The leaks started shortly after the initial installation, and many unsuccessful attempts had been made to fix them over the years.

GE was familiar with EXTECH's work with retrofits and daylighting systems, so they reached out to us. Utilizing our SKYGARD 3300 system, we renovated several types of skylights throughout the facility – including monumental ridge and barrel vault.

The biggest challenge was with the large barrel vaults in the atrium which were comprised of curved skylight panels with hundreds of leaking joints. We designed a retrofit system wherein we removed the top half of the existing framing system and created compatible aluminum extrusions to allow the installation of new panels. Those panels ran from ridge to the eave with no horizontal joints required, thus eliminating the risk of leaks. EXTECH also replaced areas of metal roofing that were allowing additional leaks.

CAD and Specification documentation available on our website.
System sample available upon request.

Lightweight components are designed to attach to the existing structure.

Lightweight panels allow for easy installation; designed to endure a wide range of weather systems.

Accepts glass, monolithic, or cellular polycarbonate sheets from 1/4" to 1" thick.



SKYGARD 3300® SURFACE MOUNTED SKYLIGHT

EXTECH's SKYGARD 3300 skylight system is an aluminum mullion skylight designed with ease of installation in mind while being able to endure a wide range of weather systems. The SKYGARD 3300 skylight is a non-structural 'skin' system that requires continuous structural support and is ideal for over-glazing or retrofit applications where existing structural members will remain in place. It can be used for a wide range of applications, from industrial factories to recreation facilities.

FURTHER BENEFITS AND DETAILS

- ▶ Accepts glass, monolithic, or cellular polycarbonate sheets from ¼" (6mm) to 1" (25mm)
- ▶ Deep glazing pockets and low-friction gaskets allow for thermal movement of glazing
- ▶ Finish on aluminum framing can be anodized or high-performance factory baked paints
- ▶ Lightweight components designed to attach to the existing structure
- ▶ Plastic spacers for thermal improvement of the system as well as positive stops to control gasket pressure
- ▶ Optional cover caps available
- ▶ LEED credits available for 100% recyclable polycarbonate glazing and aluminum framing
- ▶ Air infiltration (ASTM E-283): .03 cfm per square foot at 12 PSF
- ▶ Water infiltration (ASTM E-331): No leakage at 12 PSF

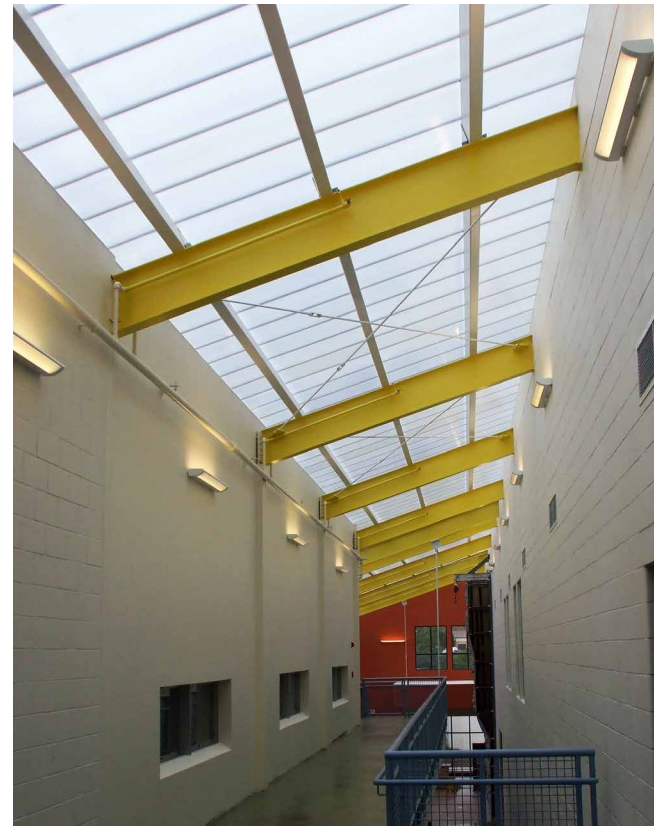

SKYGARD 3700[®]

SELF-SUPPORTING SKYLIGHT

EXTECH's SKYGARD 3700 skylight system is capable of spanning large openings. Its stainless steel joinery makes for easy installation while delivering superior air and water infiltration performance. It can be used in a wide range of configurations, including single slope, ridge types (A frame), pyramid type, ridges with hipped edges, vertical applications, and custom configurations.

FURTHER BENEFITS AND DETAILS

- ▶ Will accept polycarbonate or glass glazing up to 1" thick
- ▶ Finish on aluminum framing can be your choice of anodized or high-performance factory baked paints
- ▶ Deep glazing pockets (rabbet depth) properly allow for thermal movement of polycarbonate glazing
- ▶ Leakage and condensation are controlled by separate gutters
- ▶ Internal gutter system is unbroken by mounting fasteners
- ▶ Capable of unbroken glazing sheets up to 54' long, reducing or eliminating leak-prone horizontal joints
- ▶ Overlapping joinery allows for dimensional variations and provides excellent air & water infiltration resistance
- ▶ "Dry Glazed" - incorporates low friction gasketing to maintain good air & water infiltration seal, while allowing for thermal movement of the glazing
- ▶ Optional cosmetic cover caps available

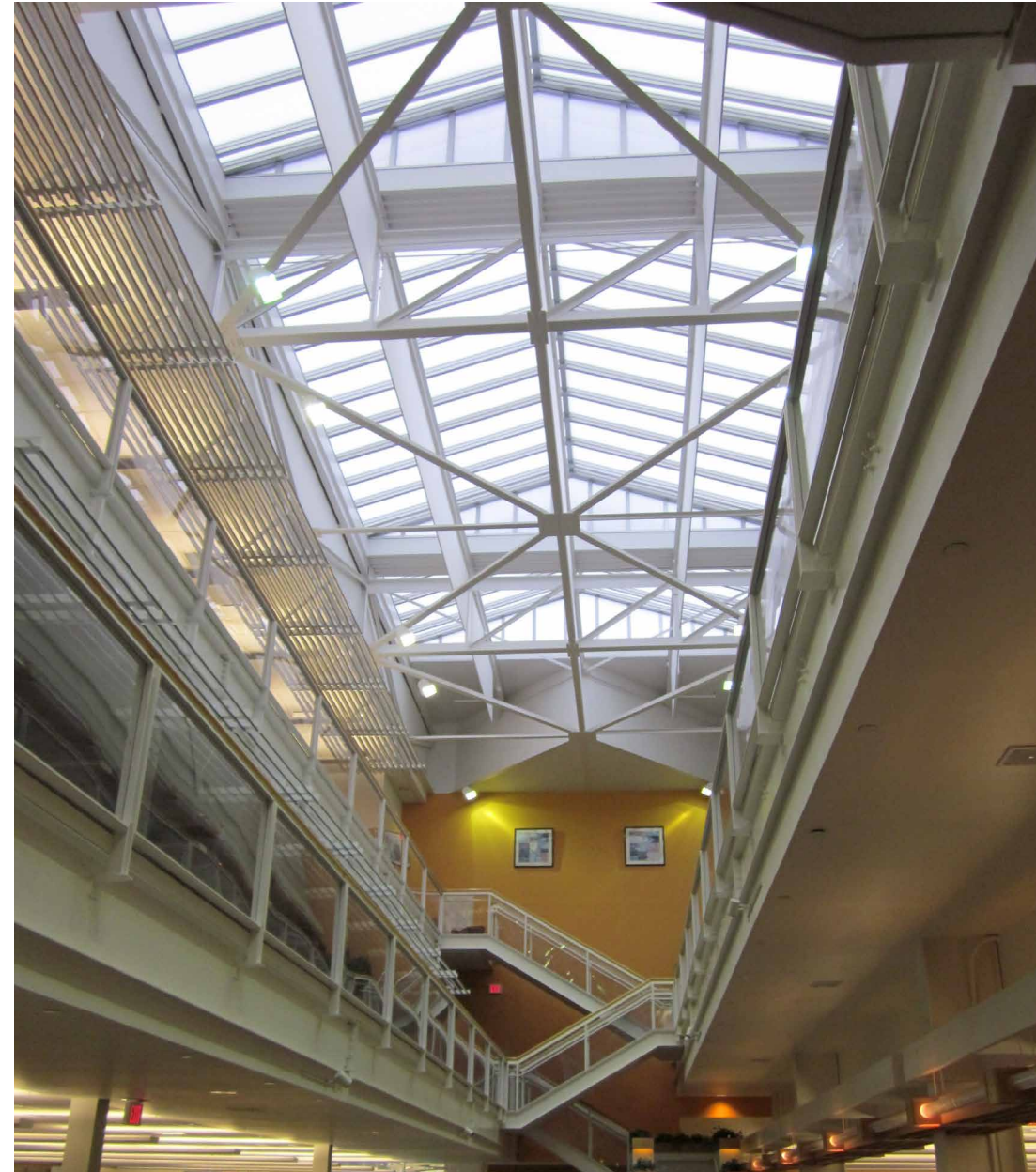

CAD and Specification documentation available on our website.
System sample available upon request.

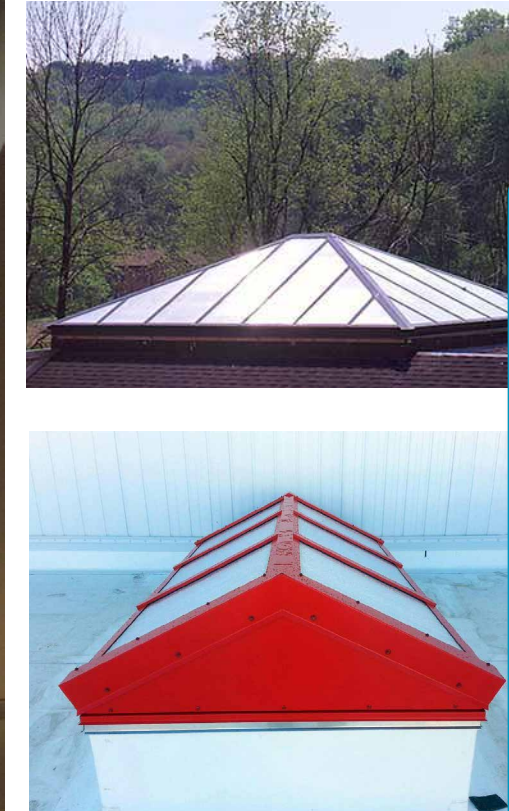

"Dry Glazed" - incorporates low friction gasketing to maintain good air & water infiltration seal, while allowing for thermal movement of polycarbonate glazing and reducing noise caused by thermal movement.

Condensation gutter prevents condensation from dripping into the structure.

Deep glazing pockets (rabbet depth) allow thermal movement of polycarbonate glazings. The system is self-supporting and can span large openings, accepting glazing up to 1" thick.

KINETICWALL™

MOVING DYNAMIC FACADE

LOGAN AIRPORT PARKING EXPANSION | BOSTON, MA

DESIGNED BY ARROWSTREET

The Massachusetts Port Authority needed a modern parking facility at Logan Airport. Because of the prominent location, they sought a 21st-century design that incorporated sustainable materials and delivered a dynamic look.

EXTECH created a kinetic wall based around 6-inch square curved aluminum flappers. To provide the visual experience that would elevate the facility from parking station to art installation, EXTECH assembled the 48,000 flappers into 350 unitized panels to capture the dynamic patterns of the wind coming off the Atlantic Ocean. The flappers provide an array of cost and sustainability benefits – they allow air to flow through and ventilate the building, permit visibility from the inside, and deflect solar heat gain.



KINETICWALL™

MOVING DYNAMIC FACADE

The KINETICWALL is a dynamic moving façade that creates an eye-catching aesthetic. Made of 6-inch flappers attached to stainless steel rods, the KINETICWALL responds to wind currents to create the look of rolling waves. It offers a host of ‘smart design’ benefits, and can be customized with a variety of shapes, colors, and materials. The KINETICWALL is a state-of-the-art yet economical way to create breathtaking, beautiful designs.

FURTHER BENEFITS AND DETAILS

- ▶ Winner of the 2017 Architizer A+ Awards Jury Prize
- ▶ Can help save money on Arts in Transit and percent-for-art compliance
- ▶ Customizable; can incorporate a wide variety of materials
- ▶ Aesthetic can be further enhanced with color-changing paint
- ▶ Can be used on small and large-scale façades
- ▶ Light-weight flappers allow for easy installation
- ▶ Can be designed to withstand hurricane-force winds and rainfall
- ▶ Facilitates easy air flow for ventilation; hugely beneficial to parking garages for this purpose
- ▶ Permits interior visibility
- ▶ Deflects the sun, preventing solar heat gain
- ▶ Spacers between flappers prevent collateral noise
- ▶ LEED credits available for 100% recyclable aluminum and stainless steel flappers and framing

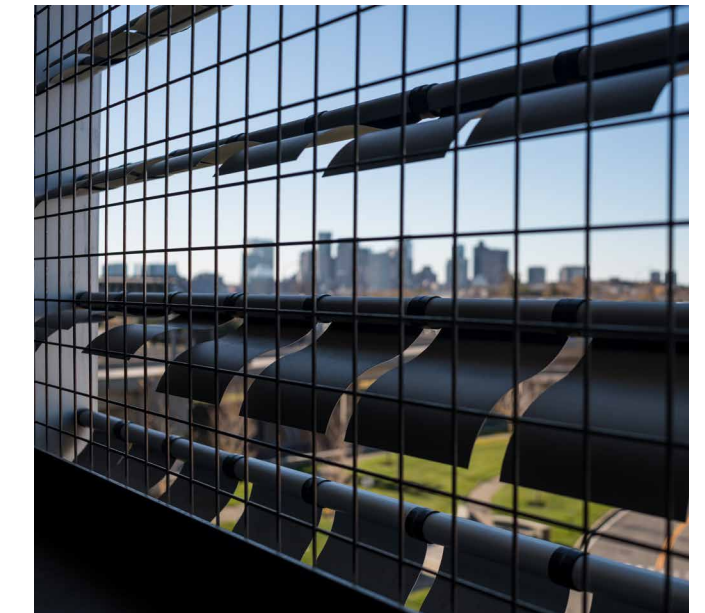
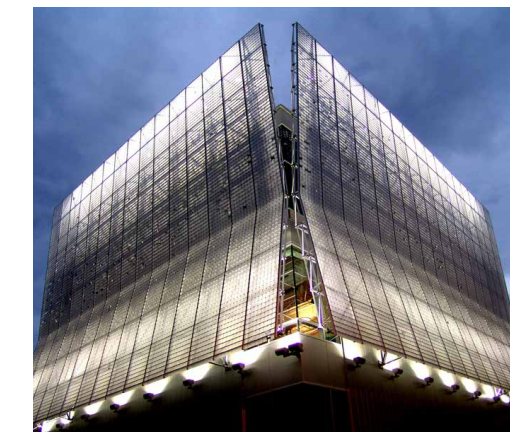

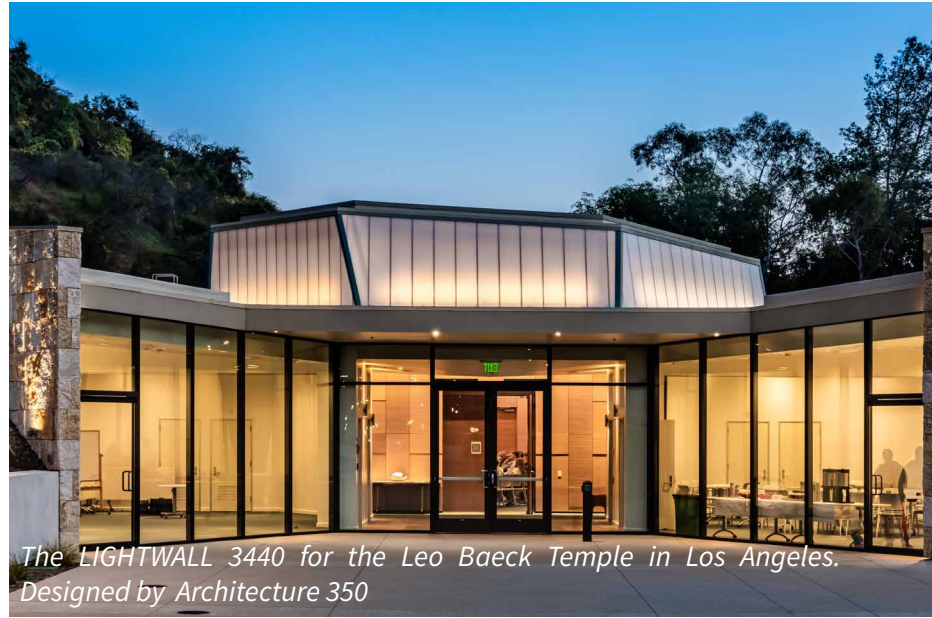

The LIGHTWALL 3440 for the Leo Baeck Temple in Los Angeles. Designed by Architecture 350



The LIGHTWALL 3440 for the Doubletree Hotel in Billings, MT



The LIGHTWALL 3440 for the Eleanor Boathouse in Chicago. Designed by Studio Gang



A custom designed Prodeema panel facade for the UNO School in Chicago. Designed by UrbanWorks, Ltd. Winner of the 2013 ALA Award for Gold Medal Design

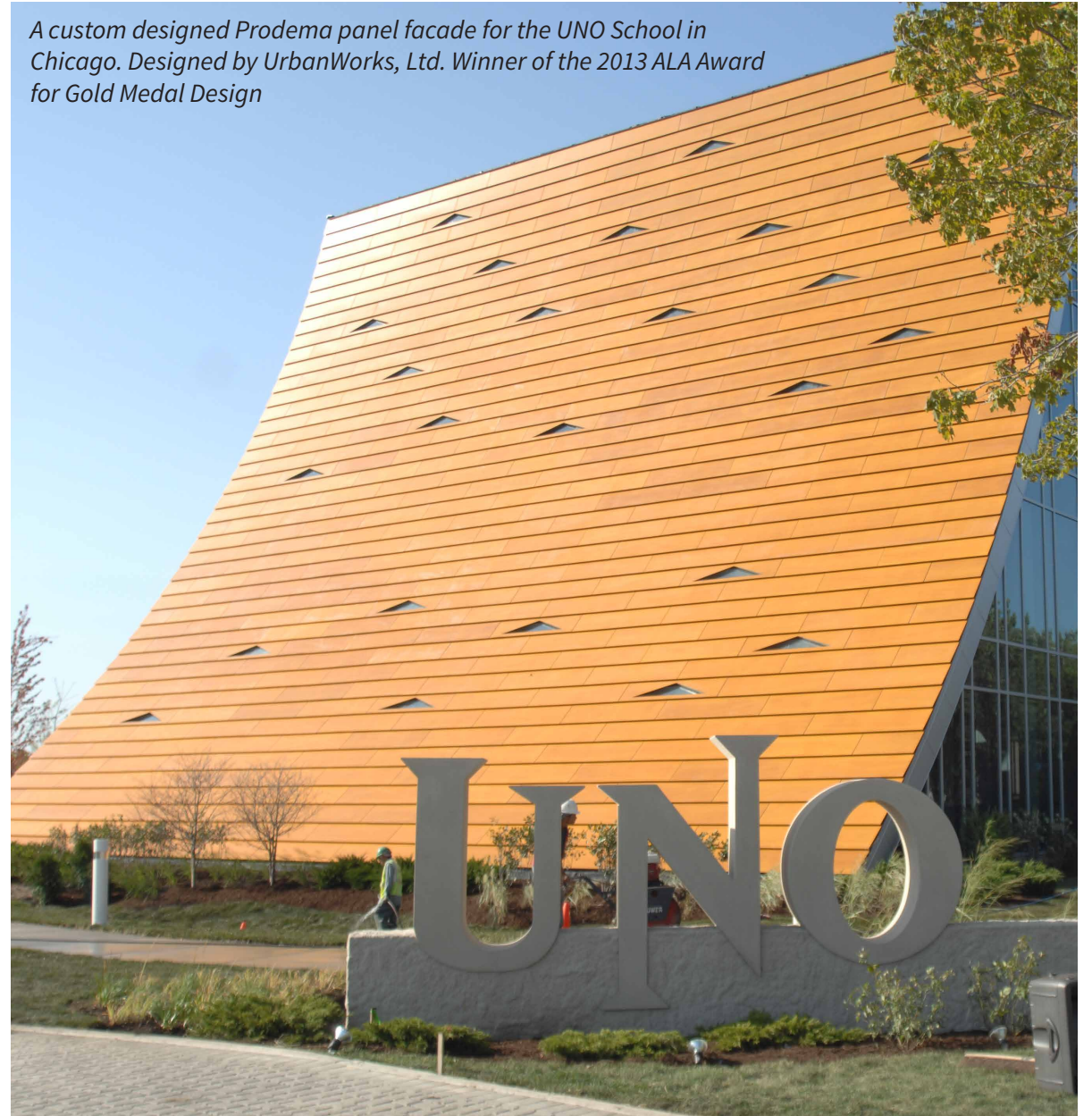
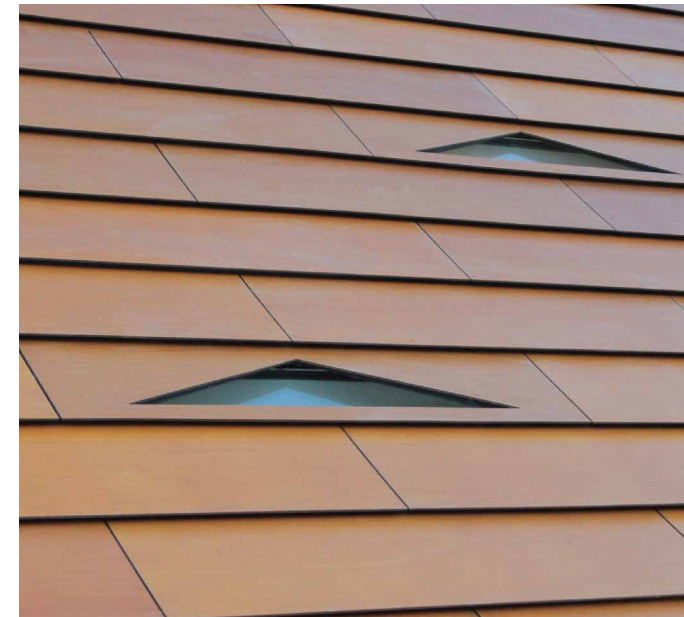

EXTECH

EXTERIOR TECHNOLOGIES. INC.



200 Bridge Street
Pittsburgh, PA 15223
1 800 500 8083
www.extechinc.com

EXTECH / Exterior Technologies, Inc. is an award-winning manufacturer and designer of wall, window, skylight, canopy, and custom façade systems. We deliver solutions for a variety of industries and applications, and are committed to collaboration, innovation, and exceptional engineering.

Visit our website at www.extechinc.com to view 3D models of our systems, download CAD and Specification documents, and read detailed case studies on past projects.